



MIXPAC™ 2-Component Dispenser

MIXPAC™ DS

A manual dispenser for BS-System cartridges.

Cartridge Support

Flap designed for maximum cartridge support and for easy cartridge exchange

Plunger System

Easy to exchange

Release Button

Easily accessible with one hand

Trigger

Dual drive to ensure even high viscosity materials maintain their mixing ratio

Ergonomic Handle

For maximum comfort



Product advantages

- Designed specifically for Mixpac BS system cartridges
- High gearing ratio
- One-handed operation

Customer benefits

- Easy cartridge positioning and fixation
- Swift and easy to use, clean application
- Ergonomic
- Can easily be converted into different ratios with proper plunger.
- Easily customized with customer print.

Applications

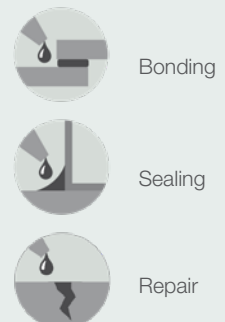

Product by range



The MIXPAC™ DS - designed to provide reliable 2-component dispensing.

Specifications

- Weight 215g / 0.47lbs
- Length: 109mm / 4.3in
- Tool material: PPO & reinforced nylon
- Cartridge capacity: 50-75mL
- Cartridge ratio: 1:1/2:1/4:1/10:1

Dimensions

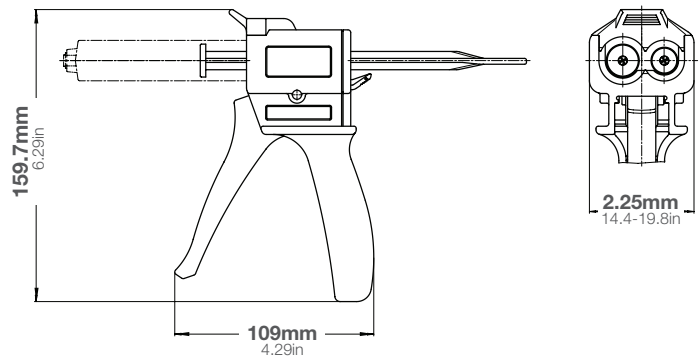

Part number:	Article number:	Ratio			
		1:1	2:1	4:1	10:1
DS 51-04-00	109146			✓	
DS 51-10-00	101929				✓
DS 53-01-00	101934	✓	✓		
DS 75-10-00	115676				✓
DS 77-01-00	110938	✓			

Packaging:

Packed individually 64 units per master carton (50mL)
Packed individually 32 units per master carton (75mL)

Matching MIXPAC™ cartridges (BS-System)



50mL / 1:1
PP/PA



50mL / 2:1
PP



50mL / 4:1
PP/PBT



50mL / 10:1
PP/PBT



75mL / 1:1
PP



75mL / 10:1
PBT

Other matching cartridges

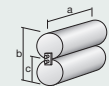

1:1	mm	inch
a	109	4.29
b	50	1.97
c	Ø 22	Ø 0.87

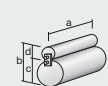

2:1	mm	inch
a	109	4.29
b	50	1.97
c	Ø 26	Ø 1.02
d	Ø 19	Ø 0.75

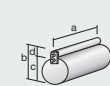

4:1	mm	inch
a	109	4.29
b	47	1.85
c	Ø 28	Ø 1.10
d	Ø 15	Ø 0.59

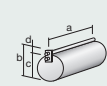

10:1	mm	inch
a	109	4.29
b	47	1.85
c	Ø 30	Ø 1.18
d	Ø 11	Ø 0.43

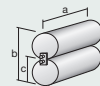

1:1	mm	inch
a	155	6.14
b	50	1.97
c	Ø 22	Ø 0.87

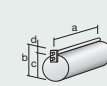

10:1	mm	inch
a	156	6.14
b	47	1.85
c	Ø 30	Ø 1.18
d	Ø 12	Ø 0.47

Conversion kits

PLS 053-01, PLS 051-04, PLS 051-10, PLS 075-10, PLS 077-01, See page 18.

Matching accessories

All accessories are displayed on page 18.